

ARMADILLO TOUGH

QUALITY COVERS BY TECNI-QUIP

- DRAPE COVERS FOR CARTS OR SHELVING
- BULK CARTS AND BASKETS
- ROUND-TRIPPERS
- FRONT COVERS OR PANELS
- SUPPLY CARTS
- CUSTOM CAPABILITIES TO MEET YOUR NEEDS 100%



SURPRISINGLY AFFORDABLE & EASY TO ORDER!

NEW
POPULAR
PASS-THRU
TRANSPARENT
STYLE AVAILABLE
NOW!

**Tecni
Quip**
Carts & Covers





ARMADILLO TOUGH CART COVERS & MORE FULL DRAPE COVERS STANDARD & CUSTOM

The TQ
Promise - Our
Covers fit "Your"
Carts like a
Glove!

STANDARD FEATURES:

3 Material Types to Choose From – Fire Retardant:

- Poly Denier 200 or 400 count
- 10 oz. Vinyl
- 16 oz. Vinyl

Variety of Colors – to complement any décor!

(See page 4 for color and option samples)

FEATURES:

- Zipper or Velcro Closures
- Velcro Ties – located inside corner seams, every 15 inches. Fastens cover to cart's frames – keeps cover intact and looking beautiful!
- A Measurement Guide is at the end of the brochure.

FULL DRAPE COVERS: For any brand, size or style of cart or shelving.



Round Style Drape Cover, fits beautifully



Square Style Drape Cover with Transparent Front Flap: allows viewing of inventory, not:



Square Style Shelving Cover: ideal for all types of shelving



Velcro Ties: Standard Features Secures cover to cart edges

SMALL CART COVERS:

Created to fit any size of small cart. Choose from a variety of materials types and colors. Handle cut-outs available. Please see measurement guide for details and contact us.

BASKET TYPE CART COVERS:

Designed to fit any size or brand of basket type cart. Standard with bungee cord at top. Upgrade with 12" overhang on edges, allows cover to rise and fall with load and still fit and cover the cart's body. See measurement guide for details and contact us.



Round Tripper Cart (B)

LAUNDRY TRANSPORT -

BULK CART^(A) OR ROUND TRIPPER^(B):

Your choice of either Full Drape Style or Cut out Cap Style. Both will cover cart and protect linens or supplies.



Bulk Cart (A)



Contact a Cover Expert Today!

Tecni-Quip Carts

Toll Free **800-826-1245** • Local & Int'l Ph: 830-401-4400

Fax: 830-401-0600 • TQind.com • Email: TQcarts@tqind.com



After years of Research & Manufacturing TQ "Perfected" The Pass-Thru Cover System!

- **Drape Cover Styles** for any Brand or Size of Cart
- **Available on New TECNI-QUIP Carts - any Model**
- **Retro Fit Front Covers on Existing TECNI-Quip Carts or any Cart or Shelving Size or Brand**

Our NEW **PT-Covers** are designed with **ECONOMICAL Replaceable Strips** that any member of your linen services team can change-out when worn or torn. **SAVE \$\$\$** Eliminates buying a new cover.

Unique Replaceable Pass-Thru Strips

6" Acrylic Strips –
Just the Right Weight .040
Strips Overlap Slightly

EFFICIENT!
Linen Slips Easily out of
Cart and Contents Remain
Protected



EZ to Replace Strips Individually Secure
with Custom Fasteners *Tough & Durable --
Hospital Tested for Perfection*

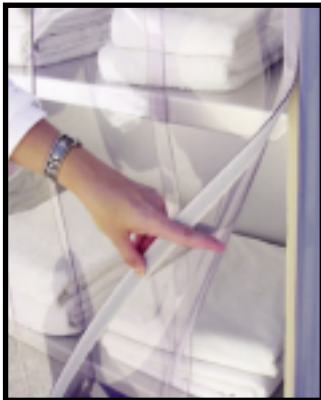

Cover Color Choices

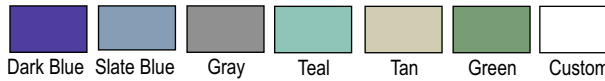

Above: **Pass-Thru on Drape Cover**
Photo Below: **All Drape Style Pass-
Thru Covers** are also equipped with a
solid front vinyl cover to seal load in
transport.

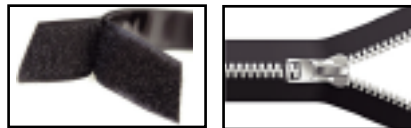

Zipper or Velcro Closures



Front Pass-Thru on
Front Cover

Optional Double Cover System
Combines Pass-Thru with Solid Front
Vinyl Cover to Seal Load during transport.
See page 4 for details.

Contact a Cover Expert Today!

Tecni-Quip
Carts

Toll Free **800-826-1245** • Local & Int'l Ph: 830-401-4400
Fax: 830-401-0600 • TQind.com • Email: TQcarts@TQind.com





COVERS

STANDARD FEATURES & OPTIONS



FABRIC SELECTION:

- **Poly Denier 200 or 400 count.**
Colors: Charcoal Grey, Tan, Dark Blue, Burgundy, other colors available.
- **10 oz. Vinyl**
Colors: Slate Blue, Mauve, Dark Blue, Tan, other colors available.
- **16 oz. Vinyl**
Colors: Teal, Slate Blue, Red, Dark Green, Gray, Dark Blue, Tan, other colors available.

Closure Choice: Zipper or Velcro

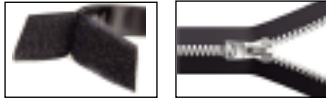

Color Choices:

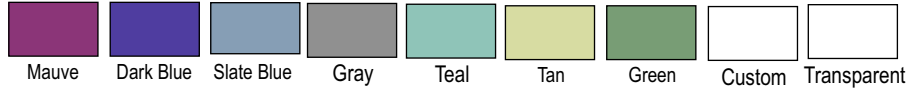

Transparent Pass-Thru Cover



Webbing for Over-the-Road Transport



Velcro ties, Standard on Drape Covers. Velcro Ties strategically placed on vertical inside edges to hold cover to frame.

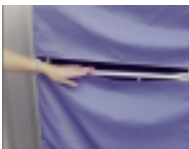

Example of Handle Cut Out

OPTIONS:

- **Transparent: Front Panel**
- **Transparent: Pass-Thru Acrylic Static Free Strips, Overlapped**
- **Double Front Cover System: Combines Pass-Thru Front Cover with 16 oz. Vinyl Cover to seal cart during transport.**
- **Replacement Strips for All Pass-Thru Covers: Unique Feature of Tecni-Quip Transport Cover System - Call for pricing and instruction.**
- **Transport Webbing** – placed on front panel for truck trailer transportation of cart.
- **Velcro Ties (standard)** – located inside corner seams, fastens cover to cart's frames – keeps drape cover intact & looking beautiful!
- **Handle Cut Outs** per your specifications, please make comments here and on the provided measurement guide. _____
- **Stenciling: (Your wording or design request)** _____
- **Custom Features You Would Like:** Describe here custom features, colors or other items. _____

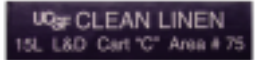

Sample of Stenciling

- **External Pockets** – collect soiled or worn linen, attached to side of cover or cart.

ORGANIZERS::

- **Transparent Routing or Inventory Pocket: Standard Size 9" x 12" or custom _____" x _____"**
- **Reject Linen External Bag: Standard Size 10" x 12" or Custom _____" x _____"**
- **Paperwork or Supply Organizers: Variety of options see photos below or custom - contact us for custom ideas.**



Transparent Inventory or Routing Pocket



Reject Linen Bag



External Pocket for Paperwork or Form Organizer



5 Pocket Supply Organizer



10 Pocket Supply Organizer

Contact a Cover Expert Today!

Tecni-Quip Carts

Toll Free **800-826-1245** • Local & Int'l Ph: 830-401-4400

Fax: 830-401-0600 • TQind.com • Email: TQcarts@TQind.com



**FIRE
RETARDANT**

ARMADILLO TOUGH CART COVERS & MORE



FRONT COVERS

Tecni-Quip
Customers -
Call Us First
We have records of
all past orders & can
provide you with
Part# and Price

*TQ manufactures front covers for any brand
or size of carts or shelving.*

MEASURING YOUR CART FOR A REPLACEMENT FRONT COVER

How to measure:

1. **TECNI-QUIP carts:** Required will be an outside measurement of the length and the overall height, from the floor to the top of the cart. See measurement guide for details and send to us via fax or e-mail.
2. **OTHER CART or SHELVING BRANDS:** Please see front cover measurement guide, fill out the form and send to us via fax or e-mail.

You may convert Zipper Covers to Velcro or Vice Versa

*or
You may Convert any cover to the "new" Pass-Thru Front Cover System*



TECNI-QUIP
Cart Front Cover

Cover Color Choices

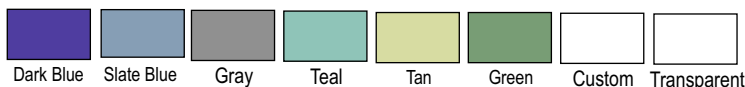

Example of
Brand X
Style Cover

Velcro or Zipper

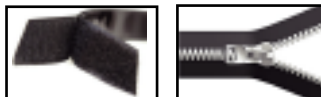

TRANSPARENT PASS-THRU FRONT COVER: Permits Easy Access to Linens and Meets Joint Commission Codes.

- Overlapping transparent strips are formed into a front panel style cover
- Permits cart's front cover to remain down at all times
- Inventory can be easily viewed, maintained and removed



DOUBLE COVER SYSTEM: Great for any transport situation in house or over the road.

- Solid Vinyl Panel with Zipper Closures is placed in front of the Clear Cover.
- This 2 cover system secures the linen load "inside the cart" during transport.
- When cart is in operation, the outer vinyl panel is positioned on top of cart, revealing the clear pass through front cover.

Contact a Cover Expert Today!

Tecni-Quip
Carts

Toll Free **800-826-1245** • Local & Int'l Ph: 830-401-4400
Fax: 830-401-0600 • www.tqind.com • Email: tqcarts@tqind.com



MEASUREMENT GUIDE FOR DRAPE COVERS & SMALL DRAPE COVERS BY TECNI-QUIP

PLEASE MAKE AS MANY COPIES OF THIS FORM AS NEEDED

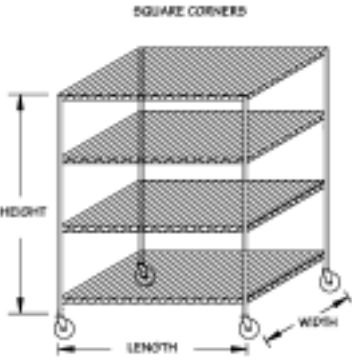

SQUARE CORNERS

DRAPE COVERS

Quantity: _____

Measurements: _____ W _____ L _____ H
(Height is from the BASE to top of the cart)

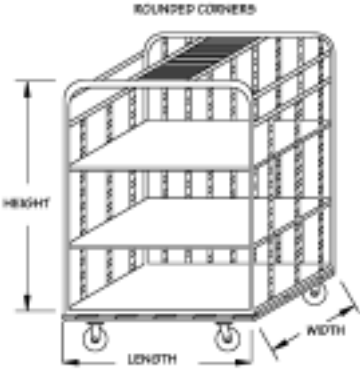

ROUNDED CORNERS

Corners: Square Rounded

Material Type: 16oz. Vinyl (Heavy Duty) 10oz. Vinyl Poly Denier

Closure: Zipper Velcro

Color 16oz. Vinyl:

Teal Slate Blue Gray Dark Blue Tan

Other Color preferred _____

Color 10oz. Vinyl:

Slate Blue Mauve Dark Blue Tan Green

Other Color preferred _____

Color Poly Denier:

Burgundy Tan Dark Blue Charcoal Grey

Other Color preferred _____

Please see **Options & Upgrade Page**

Transparent Front Only

Transparent Pass-Thru Front Combined w/Vinyl Front Cover

Handle Cut-Outs (Describe locations please)

Stenciling Your Wording: _____

Transparent routing or inventory pockets (9"x12" Standard) or your size requirement _____" x _____"

External pocket for soiled, reject linen or inventory forms

Transport Webbing

Comments/Special Request: _____

SMALL CART COVERS



Quantity: _____ Measurements: _____ W _____ L _____ H
(Height is from the top of BASE to top of the cart)

Material Type: 10oz. Vinyl Poly Denier **Closure:** Zipper Velcro

Color 10oz. Vinyl:

Slate Blue Mauve Dark Blue Tan Green Other Color preferred _____

Color Poly Denier:

Burgundy Tan Dark Blue Charcoal Grey Other Color preferred _____

Please see **Options & Upgrade Page**

Transparent Front Panel Stenciling: Wording _____

Transparent Pass-Thru Front Double Cover System

Transparent routing or inventory pockets (9"x12" Standard) or your size requirement _____" x _____"

Handle Cut-Outs: _____
Describe Location

Comments/Special Request: _____

Name _____ Title _____

Company/Facility _____

Address _____ City _____ State _____ Zip Code _____

Phone Number _____ Fax Number _____ E-mail _____

PLEASE FAX OR E-MAIL THIS INFORMATION TO US • FAX: 830-401-0600 • E-MAIL: tqcarts@tqind.com



960 Crossroads Blvd. • Seguin, Texas 78155 • Local & Int'l Ph: 830-401-4400
 Fax: 830-401-0600 www.tqind.com • TOLL FREE 800-826-1245

MEASUREMENT GUIDE FOR FRONT TYPE & BASKET COVERS BY TECNI-QUIP

PLEASE MAKE AS MANY COPIES OF THIS FORM AS NEEDED

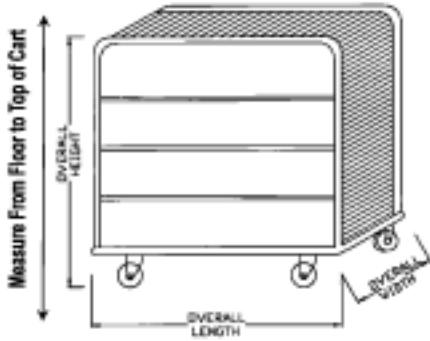

FRONT COVERS

If you are measuring a **TECNI-QUIP** cart, please record the outside width, length and height.

When measuring **OTHER BRANDS** of carts please record the length and the height where the cover is to fit.

Quantity: _____

Measurements: _____ W _____ L _____ H (Height: See above explanation.)

Please see **Options & Upgrade Page**

Corners: Square Rounded

Material Type: 16oz. Vinyl (Heavy Duty) 10oz. Vinyl Transparent Front ONLY

Closure: Zipper Velcro

Color 16oz. Vinyl:
 Teal Slate Blue Gray Dark Blue Tan
 Other Color preferred _____

Color 10oz. Vinyl:
 Slate Blue Mauve Dark Blue Tan Green
 Other Color preferred _____

Color Poly Denier:
 Burgundy Tan Dark Blue Charcoal Grey
 Other Color preferred _____

Pass-Thru Transparent Front ONLY

Double Cover System: Pass-Thru Combined with Vinyl Front Cover in Choice of Color

Handle Cut-Outs (Describe locations please)

Stenciling Your Wording: _____

Transparent routing or inventory pockets (9"x12" Standard) or your size requirement _____" x _____"

External pocket for soiled, reject linen or inventory forms

Transport Webbing

Comments/Special Request: _____

BASKET COVERS

Basket Covers Standard with: Choice of 10 oz Vinyl or Poly Denier. Cover will be constructed with 12" drop from the cart's lip with bungee to secure to the cart and tighten slightly.



Optional: Longer Drop Length at No additional cost. When choosing this option, indicate if you need bungee with the longer length.

Quantity: _____

Measurements:

_____ W _____ L _____ Drop Length Optional

Color 10oz. Vinyl:

Slate Blue Mauve Dark Blue Tan Green

Other Color preferred _____

Color Poly Denier:

Burgundy Tan Dark Blue Charcoal Grey

Other Color preferred _____

Stenciling Your Wording: _____

Comments/Special Request: _____

Name _____ Title _____

Company/Facility _____

Address _____ City _____ State _____ Zip Code _____

Phone Number _____ Fax Number _____ E-mail _____

PLEASE FAX OR E-MAIL THIS INFORMATION TO US • FAX: 830-401-0600 • E-MAIL: tqcarts@tqind.com



960 Crossroads Blvd. • Seguin, Texas 78155 • Local & Int'l Ph: 830-401-4400

Fax: 830-401-0600 www.tqind.com • TOLL FREE 800-826-1245

MEASUREMENT GUIDE FOR BULK & TURN-ABOUT "ROUNDRIPPER" CART COVERS

PLEASE MAKE AS MANY COPIES OF THIS FORM AS NEEDED

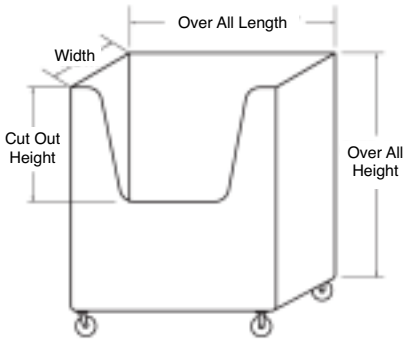

BULK COVERS

Quantity: _____

Measurements: _____ W _____ L _____ H (Height of cover should exceed Cut-Out by 2"-3")

Material Type: 16oz. Vinyl (Heavy Duty) 10oz. Vinyl Poly Denier

Please see **Options & Upgrade Page**

Handle Cut-Outs (Describe locations please)

Color 10oz. Vinyl:

Slate Blue Mauve Dark Blue Tan Green
 Other Color preferred _____

Stenciling Your Wording:

Color Poly Denier:

Burgundy Tan Dark Blue Charcoal Grey
 Other Color preferred _____

Transparent routing or inventory pockets (9"x12" Standard) or your size requirement _____" x _____"

External pocket for soiled, reject linen or inventory forms

Comments/Special Request: _____

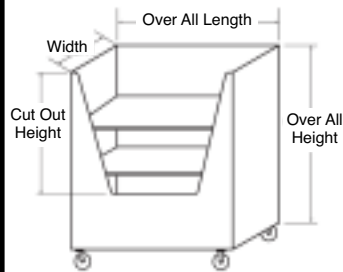

TURN-ABOUT - ROUNDRIPPER

Quantity: _____

Measurements: _____ W _____ L _____ H (Height of cover should exceed Cut-Out by 2"-3")

Please see **Options & Upgrade Page**

Handle Cut-Outs (Describe locations please)

Stenciling Your Wording:

Material Type: 16oz. Vinyl (Heavy Duty) 10oz. Vinyl Poly Denier

Color 10oz. Vinyl:

Slate Blue Mauve Dark Blue Tan Green
 Other Color preferred _____

Transparent routing or inventory pockets (9"x12" Standard) or your size requirement _____" x _____"

Color Poly Denier:

Burgundy Tan Dark Blue Charcoal Grey
 Other Color preferred _____

External pocket for soiled, reject linen or inventory forms

Comments/Special Requests: _____

Name _____ Title _____

Company/Facility _____

Address _____ City _____ State _____ Zip Code _____

Phone Number _____ Fax Number _____ E-mail _____

PLEASE FAX OR E-MAIL THIS INFORMATION TO US • FAX: 830-401-0600 • E-MAIL: tqcarts@tqind.com



960 Crossroads Blvd. • Seguin, Texas 78155 • Local & Int'l Ph: 830-401-4400

Fax: 830-401-0600 www.tqind.com • TOLL FREE 800-826-1245

Form: BTC-15